

Sheet: /	
File: controller.sch	
Title:	
Size: A4	Date:
KiCad E.D.A. eeschema 5.1.6-c6e7f7d87ubuntu19.10.1	Id: 1/1

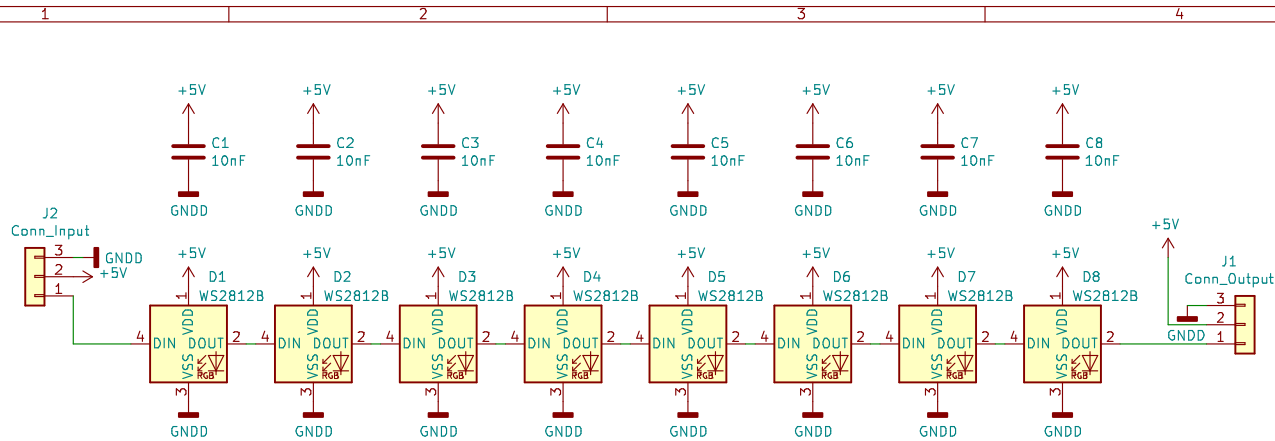

Sheet: /		File: ledpanel.sch	
Title:			
Size: A4	Date:	Rev:	
KiCad E.D.A.	eeschema 5.1.6-c6e7f7d87ubuntu19.10.1	Id: 1/1	

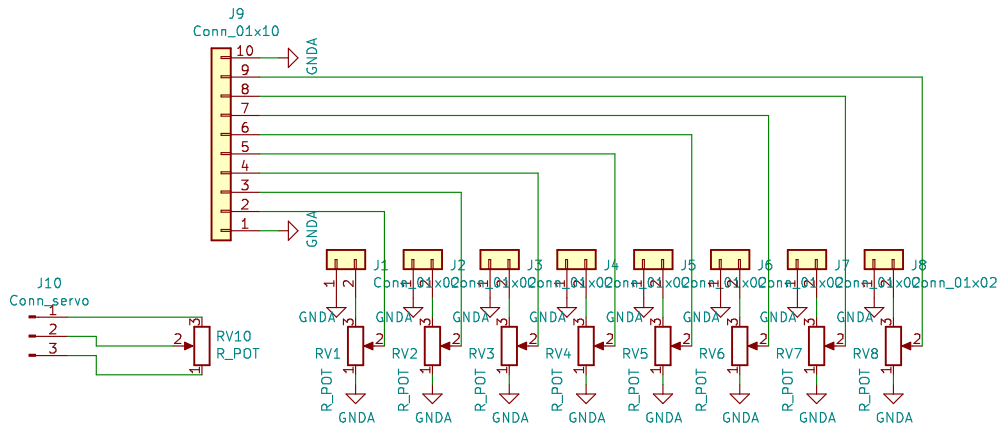

Sheet: /
 File: mainvolume.sch

Title:

Size: A4
 KiCad E.D.A. eeschema 5.1.6-c6e7f7d87ubuntu19.10.1

Date:

Rev:
 Id: 1/1

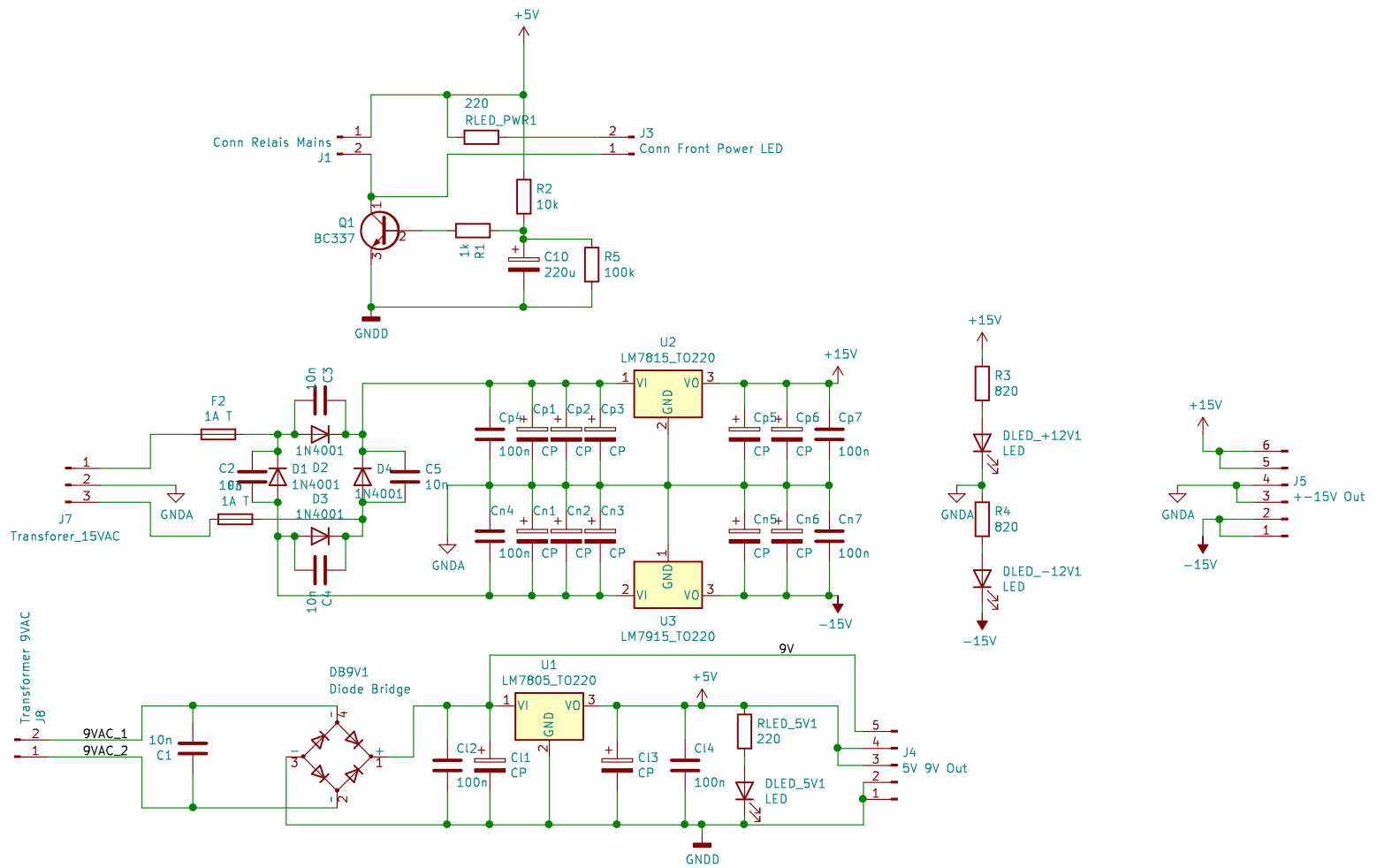

Sheet: /	
File: mixersupply.sch	
Title: Mixersupply	
Size: A4	Date: 2018-10-19
KiCad E.D.A. eeschema 5.1.6-c6e7f7d87ubuntu19.10.1	Rev: 1
	Id: 1/1

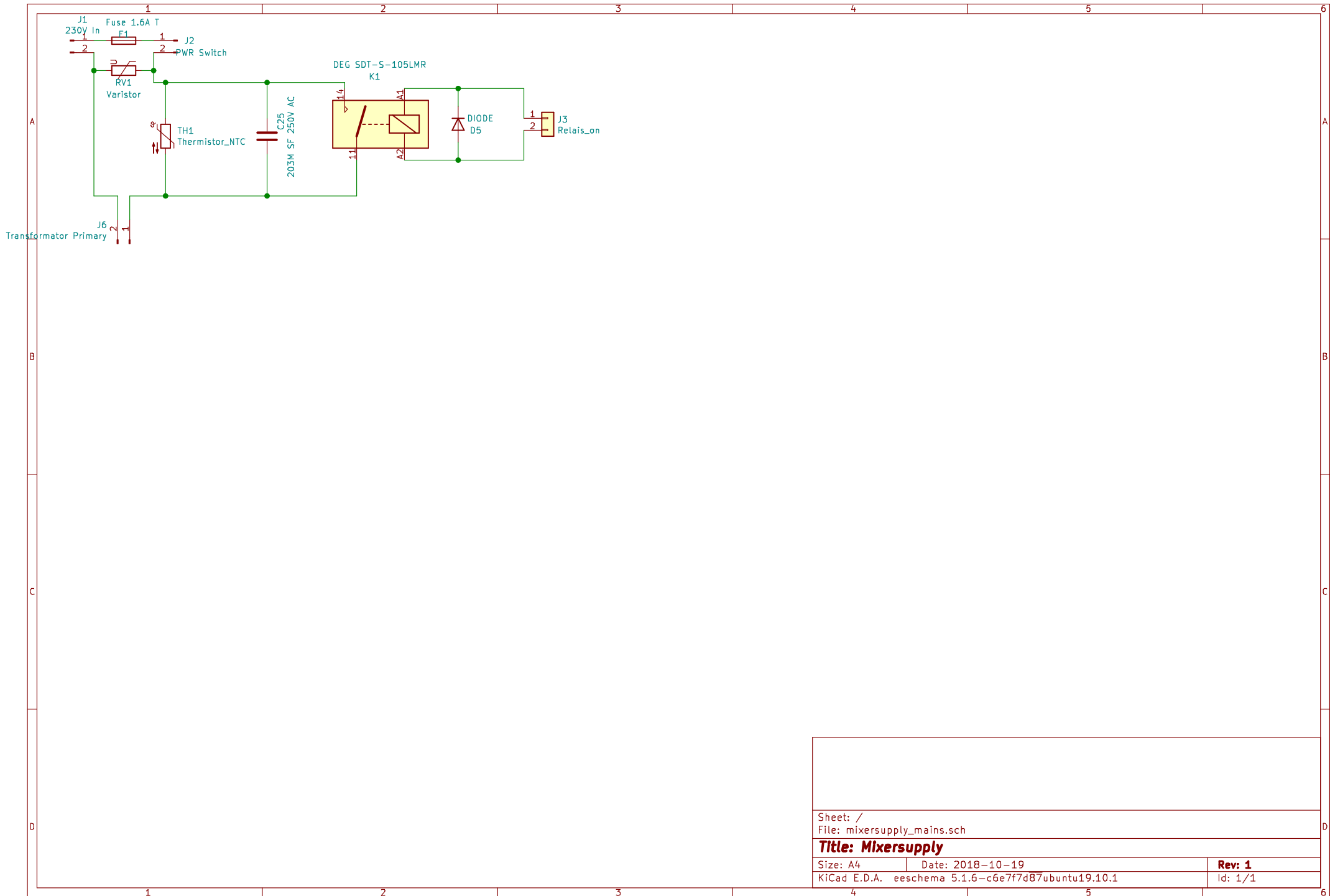

Sheet: /		Date: 2018-10-19	
File: mixersupply_mains.sch		Rev: 1	
Size: A4	KiCad E.D.A. eeschema 5.1.6-c6e7f7d87ubuntu19.10.1		Id: 1/1

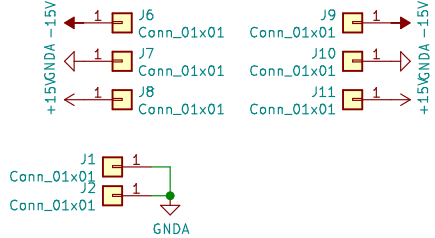
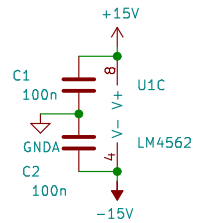

For output stage
 inA+ and inB+ are GND
 If multiple component values given separated by "|"
 first value for input buffer,
 second value for group summing configuration,
 third value for output buffer

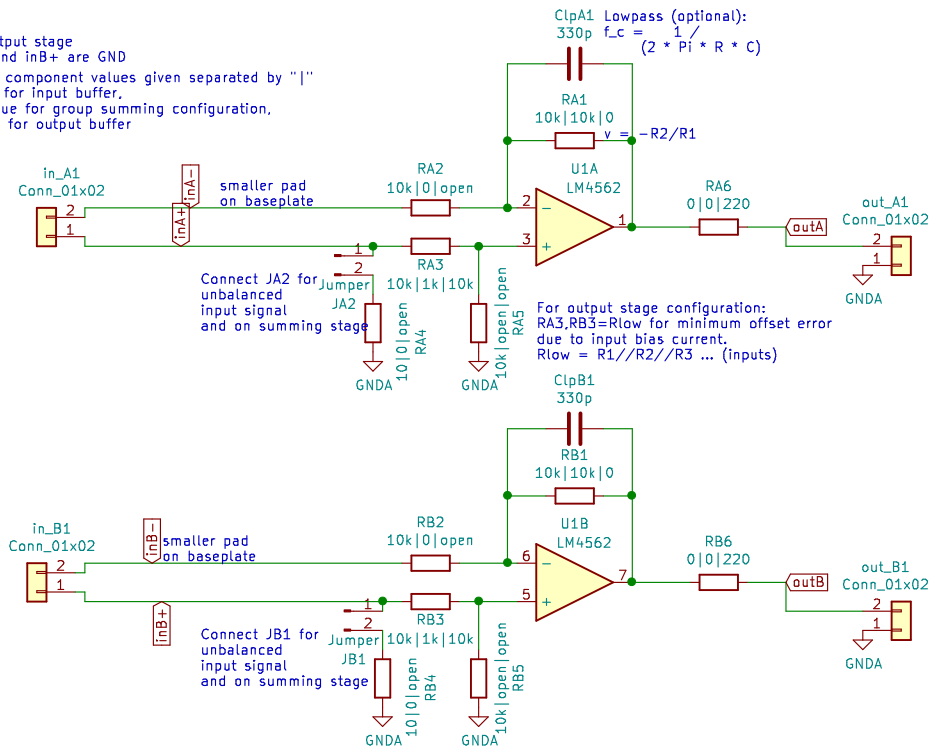

Sheet: /
 File: opamp_board.sch

Title:

Size: A4 Date:
 KiCad E.D.A. eeschema 5.1.6-c6e7f7d87ubuntu19.10.1

Rev:
 Id: 1/1

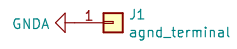
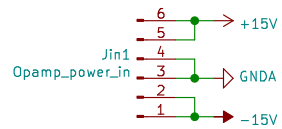

Sheet: /		
File: powerdistribution.sch		
Title:		
Size: A4	Date:	Rev:
KiCad E.D.A. eeschema 5.1.6-c6e7f7d87ubuntu19.10.1		Id: 1/1

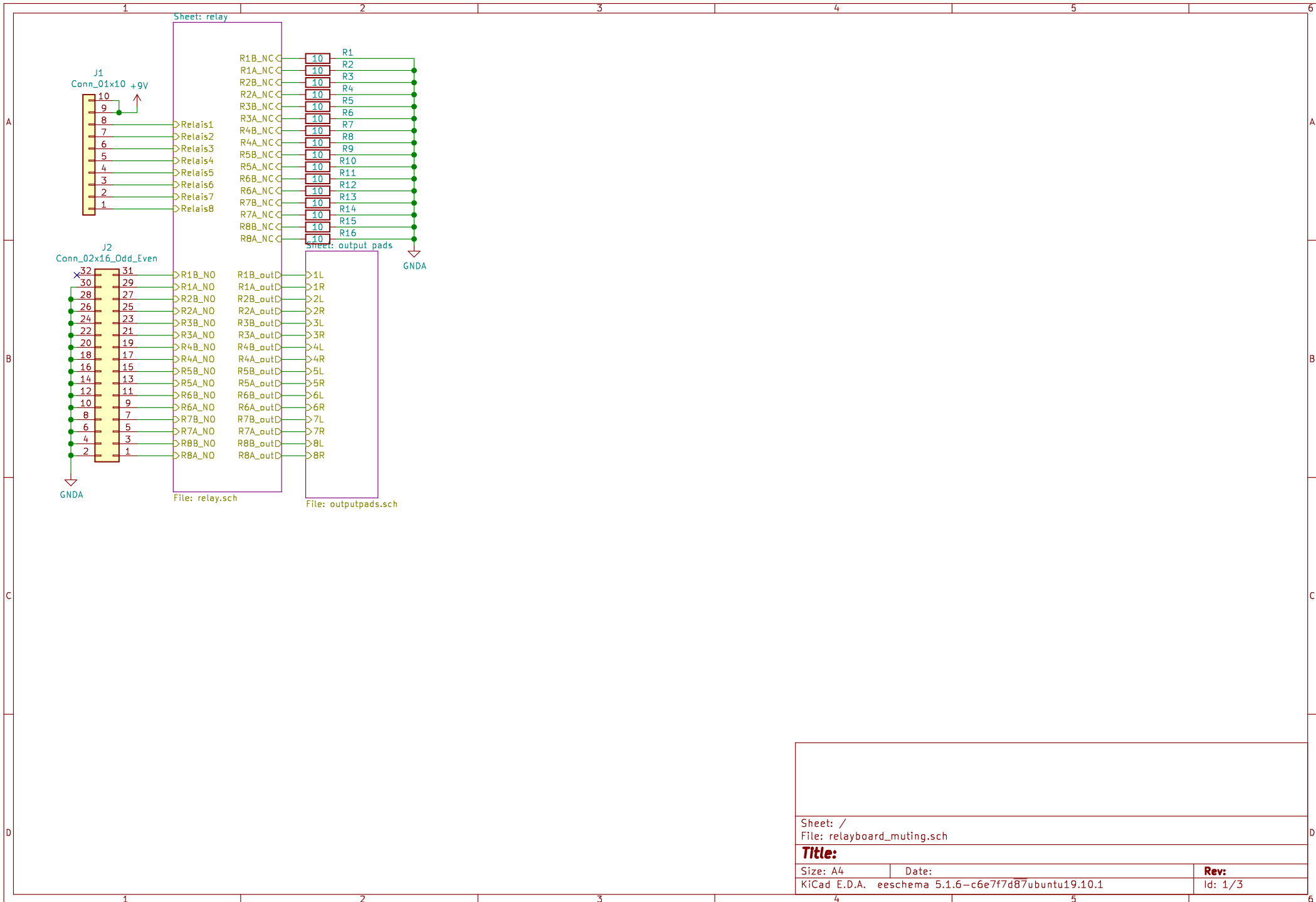

Sheet: /		
File: relayboard_muting.sch		
Title:		
Size: A4	Date:	Rev:
KiCad E.D.A. eeschema 5.1.6-c6e7f7d87ubuntu19.10.1		Id: 1/3

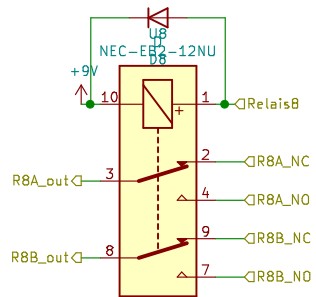
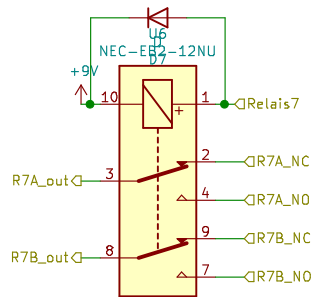
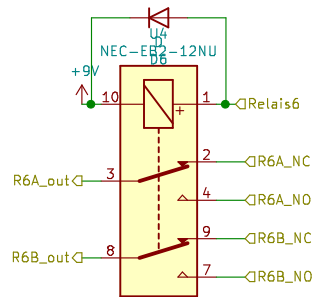
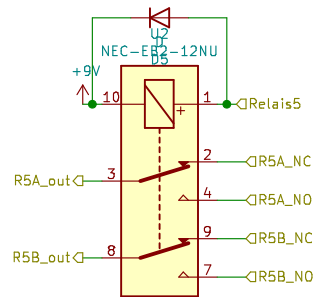
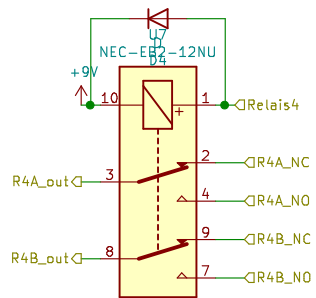
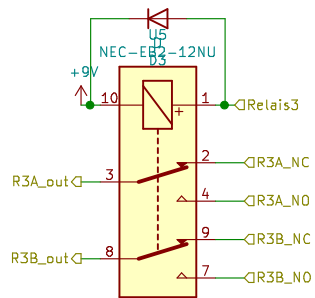
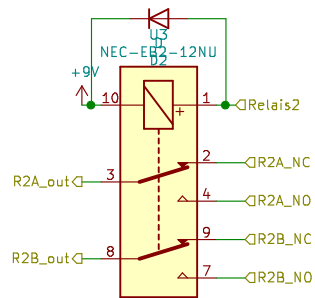
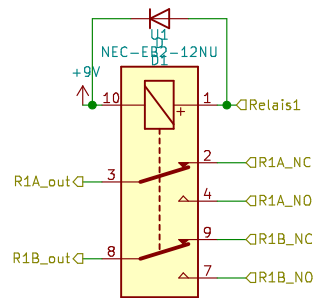

Sheet: /relay/
File: relay.sch

Title:

Size: A4 Date:
KiCad E.D.A. eeschema 5.1.6-c6e7f7d87ubuntu19.10.1

Rev:
Id: 2/3

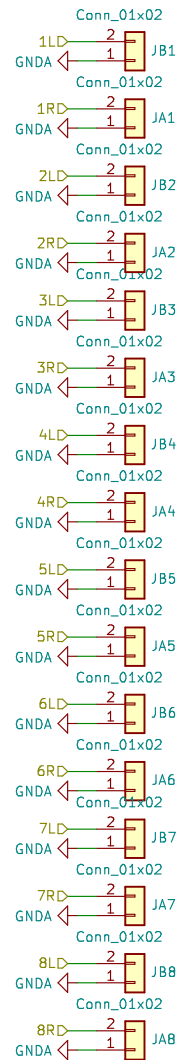

x

Sheet: /output pads/
File: outputpads.sch

Title:

Size: A4
KiCad E.D.A. eeschema 5.1.6-c6e7f7d87ubuntu19.10.1

Date:

Rev:
Id: 3/3

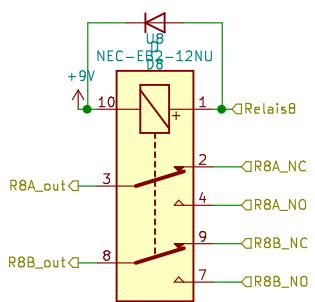
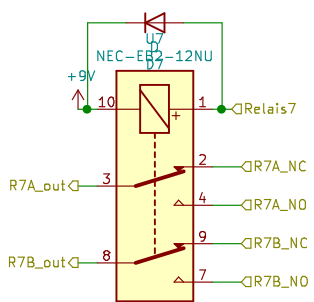
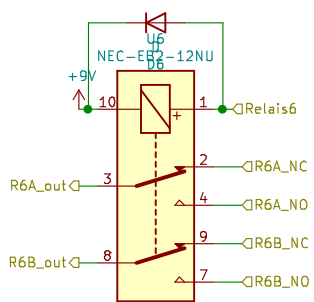
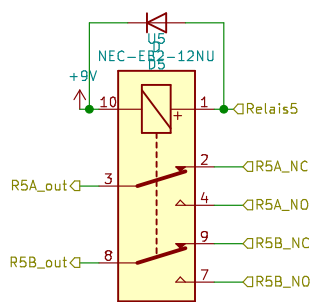
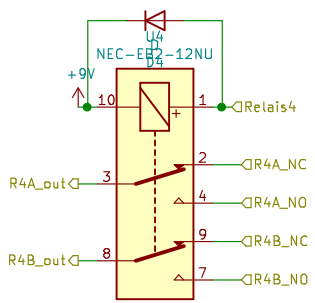
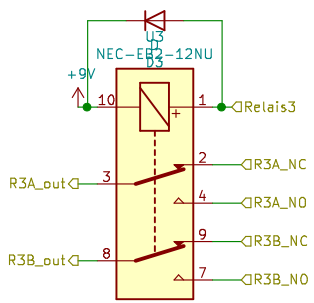
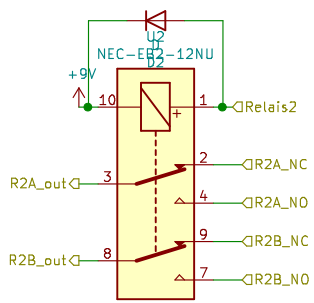
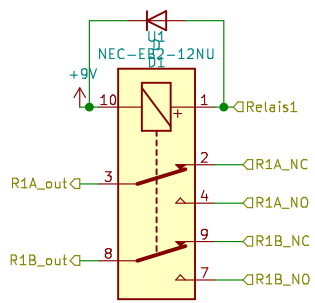

Sheet: /relaysheet/		
File: relay.sch		
Title:		
Size: A4	Date:	Rev:
KiCad E.D.A. eeschema 5.1.6-c6e7f7d87ubuntu19.10.1		Id: 2/2